

# GAMMA V-NV

Vertical multilane sachet machines

-  POWDERS
-  GRANULES
-  PASTES
-  LIQUIDS
-  TABLETS



since 1965

 MADE IN ITALY

# GAMMA V-NV Range Sachet Machines

## AUTOMATIC MULTI-LANE SACHET MACHINES GAMMA V/NV RANGE for food, pharmaceutical, chemical and cosmetic market sectors

Universal Pack's GAMMA V/NV range are vertical continuous-motion machines operating with rotary sealing rollers, to produce rectangular 4-side-seal or shaped sachets. They can be equipped with any dosing system and can accommodate a large range of

sachet sizes. The machine's output is based on the number of lanes and the cycle speed. The maximum number of lanes comes from the sachet dimensions and the cycle speed depends on the product, film, dose, sachet format and many other factors.

### BASCULATING SACHET MACHINES



Suitable for granules and free-flowing products such as sugar, salt, sweetener, pepper, black tea, creamer, instant coffee, instant tea, yeast, pharmaceutical granules and so on.

### AUGER SACHET MACHINES

Suitable for non free-flowing products containing fat that makes them lumpy, sticky and non-free flowing powders such as coffee, 3-in-1 mixes, cocoa, chocolate powder, milk powder, dry sauce mixes, spices, baking powder, yeast, pharmaceutical powders and so on.

 Granules



 Powders  
 Granules



### PISTON PUMP SACHET MACHINES

Suitable for high viscosity liquids such as ketchup, tomato paste, sauces, mayonnaise, mustard, seasonings, shampoos, toothpaste, cosmetic creams, ointments and so on.

### GRAVIMETRIC SACHET MACHINES

Suitable for low viscosity liquids such as juices, ice-pop liquids, vinegar, detergents, medicinal liquids and so on.

 Pastes

 Liquids



 Liquids



Developing the latest packaging technology since 1965



## DOSING SYSTEMS

### BASCULATING

For free flowing products

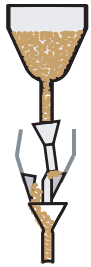

### AUGER

For powders, free and non free flowing products



### PISTON PUMP

For pasty products

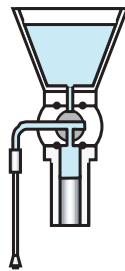

### GRAVIMETRIC

For liquid products



### ALIGNER DISPENSER

For tablets and similar products

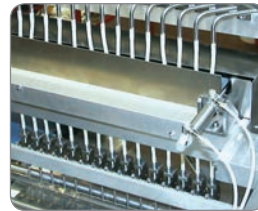
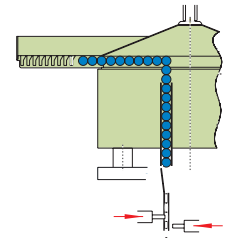

## TYPE OF SACHETS

### SQUARE



### RECTANGULAR



### ROUND



### SHAPED



### BAG IN BAG



## LAYOUTS / TECHNICAL DATA & CHARACTERISTICS / OPTIONS

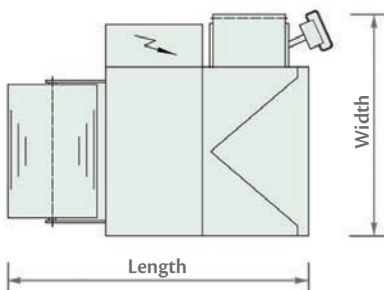

SACHET	Min.	Max
Width [mm]	25	200
Length [mm]	30	400
Dose [cm <sup>3</sup> ]	0,1	300

PRODUCTIVITY	
Output Lanes	up to 5000 sachets/min from 2 to 24

REEL	
Max width [mm]	1200
External Ø [mm]	500 or 800

	Width [mm]	Length [mm]	Max sealing width [mm]
Version P	1400	2100	200
Version S	1400	2200	280
Version M	1600	2550	450
Version G	2000	2700	600

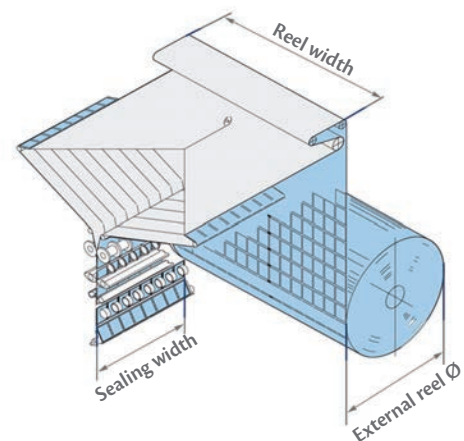

Ergonomic design and space optimization

Synchronised Brushless servomotors

Component codification

Colour touch screen monitor HMI

Quick reel splicing in an easily accessible position

Film tension control and automatic reel alignment

Ink jet, thermal transfer, embossing and laser printing

Inline sachet check-weighing with trend control feed-back

Remote factory assistance

# Special applications

Thanks to our wide knowledge and long experience we are supplying high precision packaging solutions for all kinds of business.



## GAMMA V-NV FOR BAG IN BAG

Multiple sachets (shaped or not shaped) in a sachet. 4-Side-Seal sachet technology widely used in tea and coffee industries. In order to minimize the dimensions of the outer sachet, the inner sachets are overlapped.

- Powders
- Granules
- Pastes
- Liquids
- Tablets



## GAMMA V FOR FLEXIBLE SACHET SIZES

The sachet size is flexible offering a wide range of sachet lengths and widths without mechanical intervention and adjustment in the shortest time.

- Powders
- Granules
- Pastes
- Liquids
- Tablets



## GAMMA NV FOR MORE PRODUCTS

Solutions suitable for handling products such as powders, granules, liquids, objects or a mix of them and filling two or more products in the same sachet or in separate twin sachets.

- Powders
- Granules
- Pastes
- Liquids
- Tablets



Totally client-oriented, state-of-the-art packaging solutions

## GAMMA V FOR POWDERS AND LIQUIDS

Solutions for packaging both wet and dry products such as powders, liquids and semi-dense products on the same machine. These machines feature advanced technology in terms of ease of cleaning, minimum maintenance, high flexibility and filling accuracy.

Powders 

Liquids 



## GAMMA V-NV FOR OBJECTS

Universal Pack constructs manual, semi-automatic or fully automatic feeding systems depending on the objects for special sachet applications. The possibilities are endless, please contact our sales office for more information.

Objects 



## GAMMA NV FOR SWABS

Automatic packaging machines suitable for use in the medical field for personal hygiene and in restaurants. These machines pack wet wipes, cleansing wipes, alcohol swabs, isopropyl alcohol prep pads, povidone iodine prep pads, medical swabs and so on.

Liquids 

## GAMMA NV FOR TABLETS

Vibrating tablet bowl feeders customized to exactly fit the tablet dimensions, reliable multiple-gate counting systems, broken-tablet rejection devices, checking mechanisms to align the tablets into special transfer channels ensuring that each sachet contains the exact number of tablets. Sachet can contain 1 or more tablets.

Tablets 





# Wide range of devices and facilities

## IN-LINE CHECK-WEIGHING

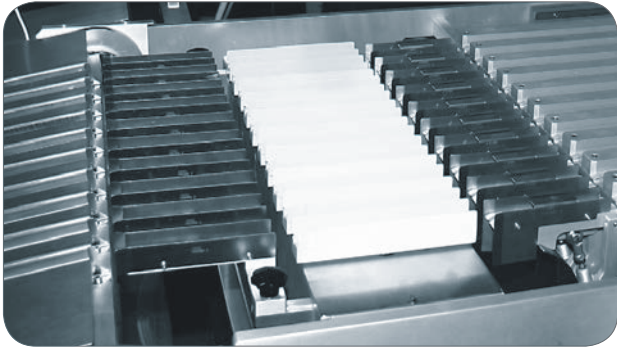

Non-commercial check weigher for inline check-weighing of produced sachets with automatic doser regulation (trend control feedback) and rejection of out of range sachets, designed and developed by Universal Pack R&D team and constructed in-house.

## PICK AND PLACE SYSTEMS



Innovative maintenance free, cleaning free, pick and place systems for positive sachets transfer and placement, designed and developed by Universal Pack's R&D team and constructed in house.

## CIP SYSTEMS



Clean-in-place (CIP) systems for cleaning the inner surface of nozzles, cylinders, pistons, all pipes and manifolds in the circuit without disassembly developed by Universal Pack R&D department in accordance with EHEDG guidelines and 3-A sanitary standards.

## MODIFIED ATMOSPHERE PACKAGING

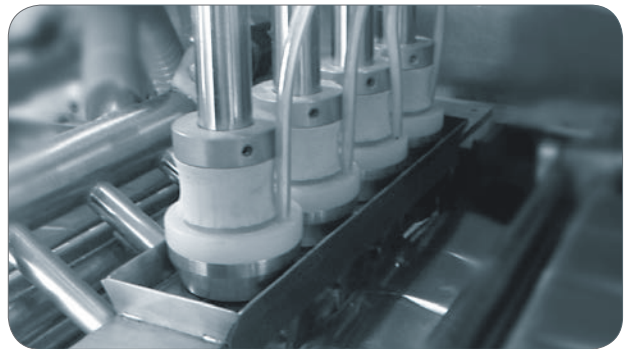

In order to improve product shelf life Universal Pack offers inline modified atmosphere packaging systems, commonly for food packaging, drugs, etc... The modification process is aimed at lowering the residual oxygen in sachets below 1%, in order to slow down the growth of aerobic organisms and the oxidation process.

## IN LINE FLEXOGRAPHIC GROUPS

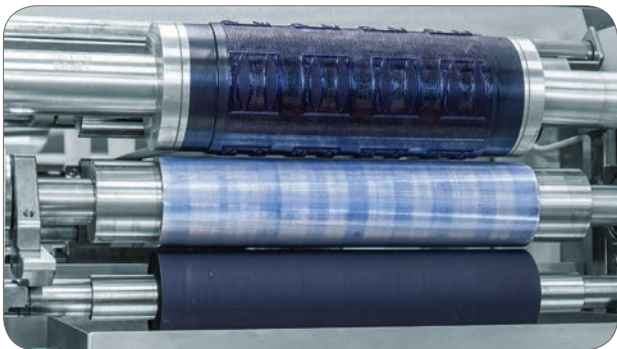

Up to three flexographic groups for inline printing during production of wording, images and subjects reproduced on photopolymer clichés. These printers allow highly customized sachets and are essential when it is not convenient to buy pre-printed reels. As the sachet represents the product, distinctive or innovative packaging can boost sales in a competitive environment.

## SWAB FOLDING GROUPS



Swab folding and insertion groups according to the desired dimensions, from a paper or "woven-non woven" reel and alcohol or disinfectant liquid injection into each sachet.

*Meticulous attention to detail and quality*

## WINDOWS PC PANEL



Innovative, compact and ergonomic monitor with a stylish design. Integrated teleassistance software enables to remotely access the machines. User, maintenance and spare parts manual and drawings integrated into LCD monitor. A 3D software allows to inspect each machine's component, in order to simplify component code research.

## TOOL LESS DISASSEMBLY



Disassembly and reassembly require a great deal of patience, care and, above all time. Most of the parts in direct contact with the product are quickly and smoothly removable without tools, conforming to cGMP criteria (easy format change and ease of cleaning and maintenance).

## HIGH PRECISION MICRO-DOSAGE

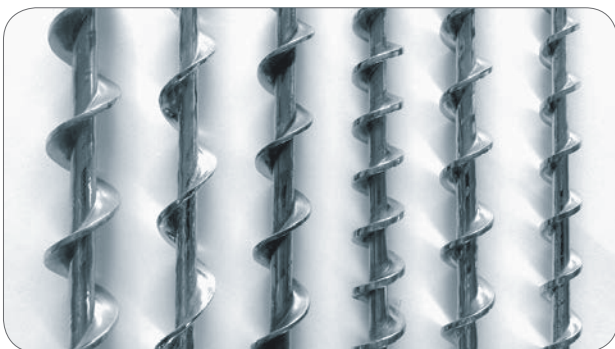

Wide range of dosing systems to enable every kind of dosing. Especially, using the smallest auger screws, it is possible to reach, with high precision, micro doses as low as 0,1 gr.

## REEL SPLICING

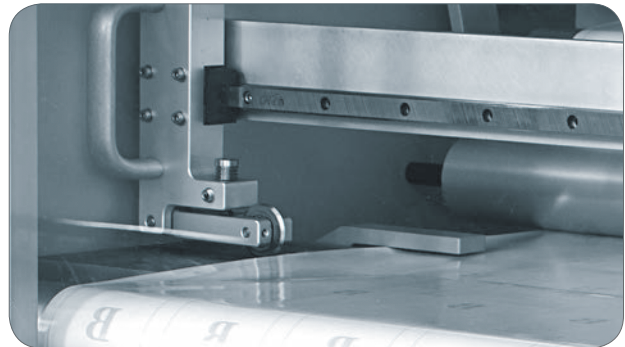

Besides the possibility to place on the machines both reels without shafts and double reels, Universal Pack has developed a new system for quick reel splicing in an easily accessible position. Thanks to these improvements reel change is faster, more user-friendly and film wastage is reduced.

## SPECIFIC MATERIALS

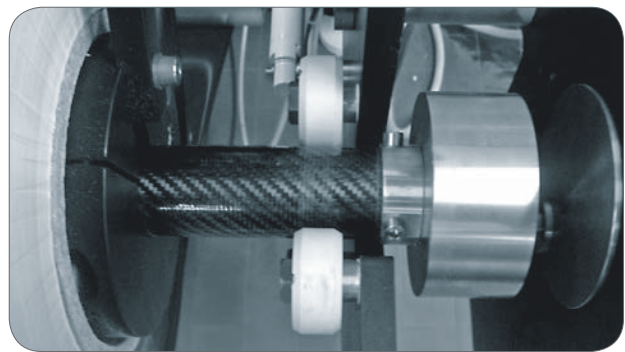

Availability of sachet machines constructed with specific materials, suitable to withstand deterioration, chemical breakdown and resistant to corrosion in pipes, valves and other metallic parts, when the product to be packed is an aggressive fluid such as acids or bases.

## IP65 & WASHDOWN



Universal Pack supplies dust-tight packaging machines with mechanical and electrical parts protected against water jets.



# Synthesis GAMMA NV Complete Automatic Lines

## USING PRE-GLUED FOLDED CARTONS

Complete automatic sachet lines entirely designed and constructed by Universal Pack composed of GAMMA NV sachet machines, Counting & stacking groups and Carton forming machines

machines equipped with suitable dosing systems for the packaging of powders, granules, liquids, tablets in sachets and subsequent automatic introduction into pre-glued cartons.



### LAYOUT

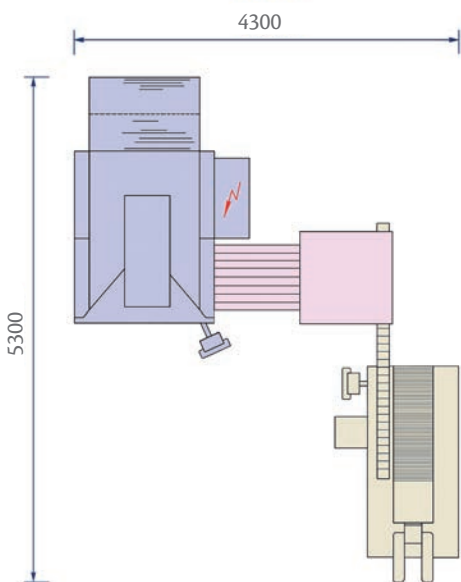

### OPERATION DIAGRAM

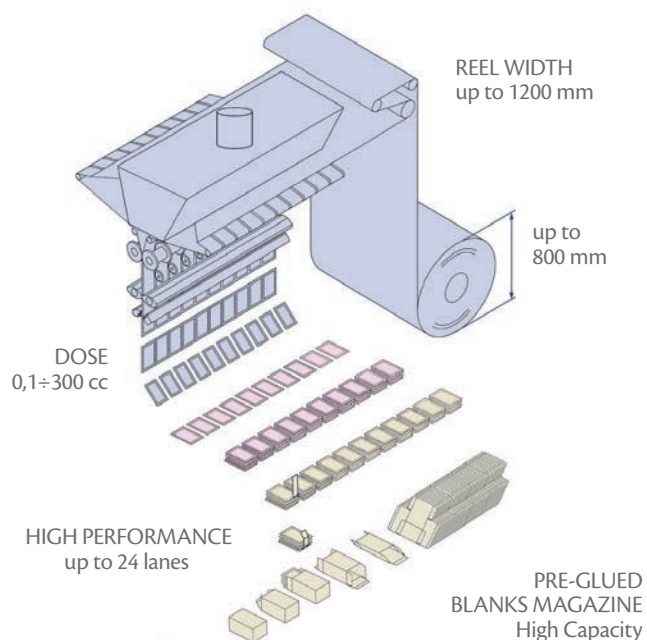

### KEY TO COLOURS

- GAMMA NV SACHET MACHINE
- COUNTING & STACKING GROUP
- CARTON FORMING MACHINE

*High efficiency, flexibility plus user-friendly design*



## USING FLAT BLANK CARTONS

Complete automatic sachet lines entirely designed and constructed by Universal Pack composed of GAMMA NV sachet machines, Counting & feeding groups, Carton erecting machines and Carton

closing machines equipped with suitable dosing systems, for the packaging of granules, powders, liquids, tablets in sachets and subsequent automatic introduction into flat blank cartons.



### LAYOUT

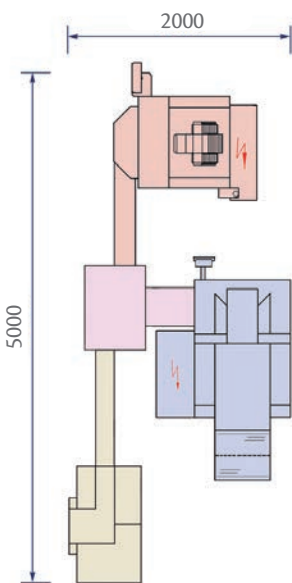

### OPERATION DIAGRAM

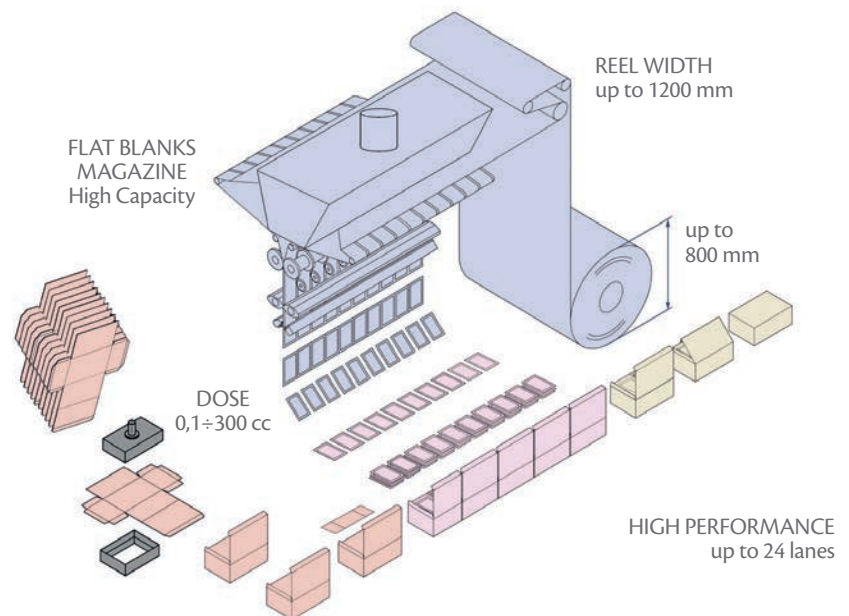

### KEY TO COLOURS

- CARTON ERECTING MACHINE
- GAMMA NV SACHET MACHINE
- COUNTING & STACKING GROUP
- CARTON CLOSING MACHINE

*Quality is not an optional, it is our daily pursuit*

# Synthesis GAMMA NV integrated lines

## SYNTHESIS GAMMA NV IN-LINE WITH POUCH MACHINERY



GAMMA NV sachet machines linked inline to vertical form fill and seal machines, for filling rectangular or shaped sachets in **pouches**.



## SYNTHESIS GAMMA NV IN-LINE WITH FLOW PACK MACHINERY



GAMMA NV sachet machines linked inline to horizontal wrapping machines for rectangular or shaped sachets and automatic wrapping into **flow pack bags**.



*Packaging solutions for every need*



## SYNTHESIS GAMMA NV IN-LINE WITH VERTICAL CARTONER



GAMMA NV sachet machines linked inline to flexible **vertical cartoning machine** for the packaging of shaped products, multipacks and pre-packed products.



## SYNTHESIS GAMMA NV IN-LINE WITH CASE ERECTING MACHINE



GAMMA NV sachet machines linked inline to an automatic case erector which seals the bottom flaps with self-adhesive tape.



# Universal Pack company profile



Founded in 1965, the factory has specialized in designing and constructing top-quality vertical multilane packaging machines and complete lines with respective cartoning systems.

The company is recognized world-wide as a packaging leader operating in the food, chemical, pharmaceutical, and cosmetic industries.

Universal pack also prides itself on customizing machinery specifically to the customer's demands. All these machines and complete lines are designed, manufactured and assembled in-house in the factory in Italy, which means Universal Pack is responsible to ensure the complete line is fully functional.

The 500 mq warehouse currently houses over 60.000 individually coded spare parts.

Universal Pack has quick and efficient access to an extensive and comprehensive computerized inventory of every single spare part, which allows for quick delivery times to customers.

Universal Pack achieved ISO 9001:2008 certification by TÜV in 2001; as a result, all relevant information is stored and easily accessible

when required. Universal Pack has the most sophisticated state-of-the-art tooling machinery, with which over 80% of our machines parts are produced. In this way not only the quality is controlled, but also the availability of the parts required either for new machine construction or spare parts.



**QUALITY MANAGEMENT  
CERTIFICATION**  
UNI EN ISO 9001:2008  
n° 50 100 1592



**INDUSTRIAL SAFETY  
CERTIFICATION**  
n° 50 100 12341/BS  
OHSAS 18001:2007

With complete control and understanding over the entire manufacturing process, Universal Pack manufactures extremely high-precision parts, quickly, effectively, with machine design innovation.



Project Design Department



Parts Workshop



CNC tooling machinery

*Universal Pack at the forefront for almost 50 years*





Universal Pack is located in San Giovanni in Marignano, on the Adriatic coast, 30 minutes from Rimini and 1 hour from Bologna, the packaging capital of Italy also known as "Packaging Valley". The nearest airports are Bologna and Ancona, while the biggest and easiest to get to are in Milan and Rome.



AIRPORT	distance
RIMINI	20 km
ANCONA	80 km
BOLOGNA	120 km
MILAN	350 km
ROME	350 km

## PEOPLE & PLANET

Lighting the way towards a sustainable future

We want to have a positive impact on people and the planet. Being a responsible company, operating more sustainably has always been part of our philosophy. We are strongly committed to invest in renewable energy and 'energy-efficient' technology to help tackle climate change. Furthermore we are constructing sachet machines and lines running with sustainable biocompostable laminates which break down naturally into organic components in 12 weeks thus reducing the impact of the wrapping materials on the environment.



Assembly Department



Warehouse



Quality Control Room

*Universal Pack R&D team is investing in biosustainable packaging*

# Universal Pack's mission

Universal Pack presents itself as a designer and constructor of highly efficient, flexible and user-friendly sachet machinery and complete lines, totally client-oriented.

## WE PRIDE OURSELVES ON:

### EXPERIENCE

Thanks to almost 50 years of experience, we have accumulated extensive knowledge about the packaging industry and its rigorous demands, we have worked with thousands of different products and laminates in all markets: food, pharmaceutical, chemical, cosmetic.

### BESPOKE SOLUTIONS

Though the basic structure of our machine is the same, almost each one we construct is unique in some way, specifically tailored to the customer's sachet size, number of lanes, dosing system, down-line, end-of-line packaging and a wide variety of options.

### HIGH-TECH & HIGH-QUALITY SOLUTIONS

Our strength lies in constructing high-speed, high-precision and high-output solutions for particularly demanding customers. We can reach speeds of up to 300 cycles per minute and on a 15-lane machine that means 4500 sachets per minute. Furthermore we can achieve very small doses up to 0,1 gr.

### ROBUST & COMPACT MACHINERY

Once our machines are properly set up, they are capable of operating at the same speed for many years and we have many customers still confidently using our sachet machines for over 25 years. Furthermore they all feature a compact footprint and ergonomic design.

### CUSTOMER SERVICE

Our main strength is our exceptional pre-sales consultation and after-sales follow up. Ongoing support, friendly assistance and courteous timely service are one of the main reasons most customer keep choosing us. Customer satisfaction is our mission and business priority.

### TRAINING

In order to improve productivity, increase reliability, maximize the operational efficiency and reduce time loss, we support our customers with appropriate instruction and training programs, so that they can quickly learn what and how to do.

### TPM

We provide customers a wide range of tools aimed at improving machine capability through a better utilization of maintenance by following the philosophy of TPM "Total Productive Maintenance".

### EXCELLENCE

Our success is achieved through meticulous attention to detail and quality.



*Entirely made in Italy with state-of-the-art technology*





Sachet & stick-pack solutions  
supplied worldwide  
for all market sectors



*A pioneer and consolidated leader in the world of packaging*



**UNIVERSAL PACK S.r.l.**  
Via Vivare, n. 425  
47842 San Giovanni in Marignano (Rimini) Italy  
Tel. +39 0541 955 276 - Fax +39 0541 955 400  
[www.universalpack.it](http://www.universalpack.it) - [info@universalpack.it](mailto:info@universalpack.it)

[www.universalpack.it](http://www.universalpack.it)

